

DCMB_YD-6W Series



FEATURES

- Wide voltage range input (2:1)
- Working temperature range: -40 °C to +85 °C
- Up to 88% efficiency
- Standby power consumption: 0.12W
- Output short circuit, overcurrent, overload protection
- 3 Years Warranty

DESCRIPTION

DC-DC module power supply, Wide voltage input, Power 6W, Isolated, Regulated, Single output, DIP packaging.

MODEL NUMBERING



SELECTION GUIDE

Product Model	Input Voltage Standard Value(range)	Output Voltage	Output Current (mA) (Max./Min.)	Efficiency % (Min./Typ.)	Maximum capacitive load (μ F)
DCMB0505YD-6W	5VDC (4.5-9)	5	1200/0	81/83	1000
DCMB0512YD-6W		12	500/0	85/87	470
DCMB0515YD-6W		15	400/0	86/88	220
DCMB0524YD-6W		24	250/0	86/88	100

Product Model	Input Voltage Standard Value(range)	Output Voltage	Output Current (mA) (Max./Min.)	Efficiency % (Min./Typ.)	Maximum capacitive load (μ F)
DCMB1203YD-6W	12VDC (9-18)	3.3	1500/0	79/79	1800
DCMB1205YD-6W		5	1200/0	81/83	1000
DCMB1209YD-6W		9	667/0	81/83	470
DCMB1212YD-6W		12	500/0	85/87	470
DCMB1215YD-6W		15	400/0	86/88	220
DCMB1224YD-6W		24	250/0	86/88	100
DCMB2403YD-6W	24VDC (18-36)	3.3	1500/0	79/79	1800
DCMB2405YD-6W		5	1200/0	81/83	1000
DCMB2409YD-6W		9	667/0	81/83	470
DCMB2412YD-6W		12	500/0	85/87	470
DCMB2415YD-6W		15	400/0	86/88	220
DCMB2424YD-6W		24	250/0	86/88	100
DCMB4803YD-6W	48VDC (36-75)	3.3	1500/0	79/79	1800
DCMB4805YD-6W		5	1200/0	81/83	1000
DCMB4805YD-6W		9	667/0	81/83	470
DCMB4812YD-6W		12	500/0	85/87	470
DCMB4815YD-6W		15	400/0	86/88	220
DCMB4824YD-6W		24	250/0	86/88	100

INPUT CHARACTERISTICS

Parameter	Conditions	Min.	Typ.	Max.	Units
Input current (Rated Load)	Nominal voltage input@5VDC	--	1536	1584	mA
	Nominal voltage input@12VDC	--	640	660	mA
	Nominal voltage input@24VDC	--	315	330	mA
	Nominal voltage input@48VDC	--	160	165	mA
Input current (No-load)	Nominal voltage input@5VDC	--	30	40	mA
	Nominal voltage input@12VDC	--	25	30	mA
	Nominal voltage input@24VDC	--	10	15	mA
	Nominal voltage input@48VDC	--	06	09	mA
Reflected ripple current		30	40	50	mA
Input impulse voltage	1sec. max.	-0.7	--	16	VDC
		-0.7	--	25	VDC
		-0.7	--	50	VDC
		-0.7	--	100	VDC
Starting voltage	Nominal voltage input	--	--	4.5	VDC
		--	--	09	VDC
		--	--	18	VDC
		--	--	36	VDC
Under voltage protect	Nominal voltage input	03	3.5	--	VDC
		5.5	6.5	--	VDC
		12	15.5	--	VDC
		26	30	--	VDC
Start Time		--	10	--	ms
Remote control foot (Some models are applicable)	Module On	Ctrl hovering or connected to TTL high level (3.5 12VDC)			
	Module shutdown	Ctrl connected to GND or low level (0 1.2VDC)			
	Input current during shutdown	--	06	10	mA
Input filter	PI type				

Remarks: This product does not support hot plug

OUTPUT CHARACTERISTICS

Parameter	Conditions	Min.	Typ.	Max.	Units
Output voltage accuracy	0% -100% Load	--	±1	±3	%
Linear regulation rate	Input voltage variation+/- 1%	--	--	±1.5	%
Load regulation rate	10% to100%load	--	±0.5	±1.5	%
Ripple & Noise	20MHz bandwidth	--	30	100	mVp p
Dynamic response step deviation		--	±3	±5	%
Dynamic response recovery time		300	500	300	us
Temperature drift coefficient	100% load	--	±0.03	--	%/°C
Output over voltage protection	Full voltage range input	110	--	160	%Vo
Output over current protection	Full voltage range input	110	140	190	%Io
Short circuit protection	Sustainable, Self healing				

Note: The Testing Method For Ripple And Noise Is The Parallel Line Testing Method.

GENERAL CHARACTERISTIC

Parameter	Conditions	Min.	Typ.	Max.	Units
Isolation voltage	Input output, test time1 minute, Leakage current less than1 mA	1500	--	--	VDC
Insulation resistance	Input output, Insulation voltage 500VDC	1000	--	--	MΩ
Isolation capacitance	Input output, 100KHz/0.1V	--	1000	--	pF
Working temperature	Temperature ≥ 71 °C for derating (See Figure4)	-40	--	+85	°C
Storage temperature		-55	--	+125	°C
Storage humidity	Non condensing	--	--	95	%RH

Parameter	Conditions	Min.	Typ.	Max.	Units
Housing temperature rise during operation	Ta=25°C,Nominal input, Full output	--	15	25	°C
Soldering temperature resistance of pins	The distance from the welding spot to the shell is 1.5mm, 10 seconds	--	--	300	°C
	REFLOW: Peak temperature Tc≤245°C, maximum time above 217°C for 60 seconds.	--	--	245	°C
Switching frequency	Full load, Nominal input voltage	--	270	--	KHz
Mean time between failiures 【MTBF】	MIL HDBK-217F@25°C	2000	--	--	kHours

PHYSICAL CHARACTERISTICS

Parameter	Conditions
Housing material	Aluminum alloy
Overall dimensions	25.40 × 25.40 × 11.70 mm
Weight	15g(Typ.)
Cooling mode	Natural air cooling

EMC CHARACTERISTICS

Parameter	Category	Content
EMI	Conductive disturbance	CISPR32/EN55032 CLASS B (The recommended circuit is shown in Figure 2)
	Radiation disturbance	CISPR32/EN55032 CLASS B (The recommended circuit is shown in Figure 2)
EMC	Electrostatic discharge	IEC/EN61000-4-2 Contact ±4KV perf. Criteria B

CIRCUIT DESIGN AND APPLICATION

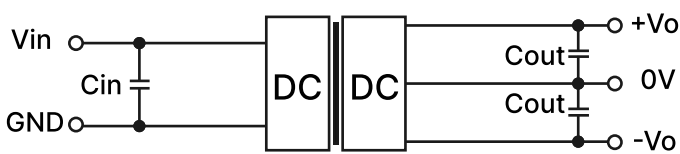

Figure 1: Application circuit

Table 1:
Recommended Capacitive Load Values

Vin(VDC)	Cin(μF)	Vo(VDC)	Cout(μF)
Nominal voltage	100	Nominal voltage	10

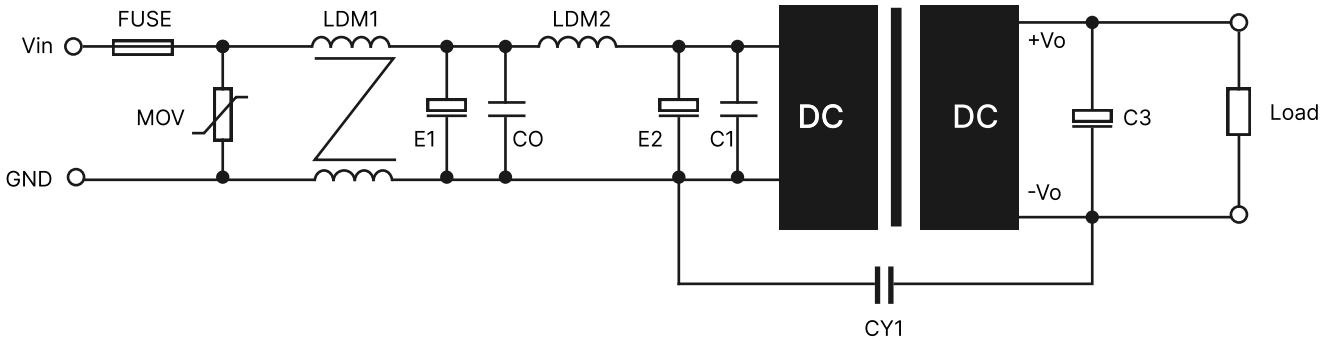

Figure 2: EMC Typical Recommended Circuits

Table 2:
Recommended Circuit Parameter Values

Category	Component	Value
EMI	MOV	14D560K
	E1/E2	100 μ F
	C0/C1	1 μ F
	CY1	1nF/2KV
	LDM1	10mH
	LDM2	10 μ H

1. Typical application: If further reduction of input and output ripple is required, a capacitor Filter network can be connected at the input and output ends. The application circuit is shown in Figure 1. However, suitable Filter capacitors should be selected. If the capacitance is too large, it may cause overcurrent or poor startup of the power supply. For each output, while ensuring safe and reliable operation, the recommended capacitance load values are shown in Table 1.
2. EMC requirements: For situations with high EMC requirements, a typical EMC recommended circuit is shown in Figure 2.
3. Input requirements: Ensure that the Fluctuation range of the input voltage does not exceed the upper and lower limits of the input voltage Specified in this data sheet, and the input power must be greater than the output power Specified in this data sheet. For situations with a 24V input voltage, it is recommended to connect a TVS tube between the positive and negative input pins for protection (recommended parameters for TVS tubes: 30V, bidirectional, SOD-123 packaging).
4. Output load requirements: Try to avoid using it without load as much as possible; When the actual power of the load is less than 10% of the rated output power in this data sheet, or when it needs to be used in no-load situations, it is recommended to connect a load resistor externally at the output end. The load resistor can be calculated according to 5-10% of the rated power in this data sheet. The calculation formula for the load resistor value is $R_L = V_{out}^2 / (P_{out} * 10\%)$.
5. Overload protection: Under normal working conditions, the output circuit of this product has no protection function for overload situations. The simplest method is to connect a self recovery fuse in series at the input end, or add a circuit breaker outside the circuit; Or during design and selection, the actual power of the circuit should be around 60-80% of the rated power in this data sheet.

PRODUCT CHARACTERISTIC CURVE

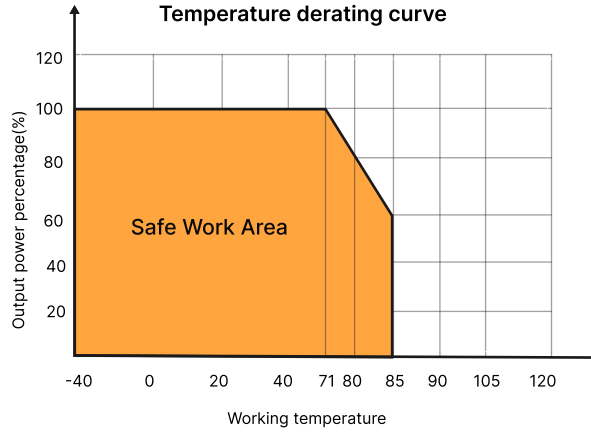

Figure 4: Temperature Derating Curve

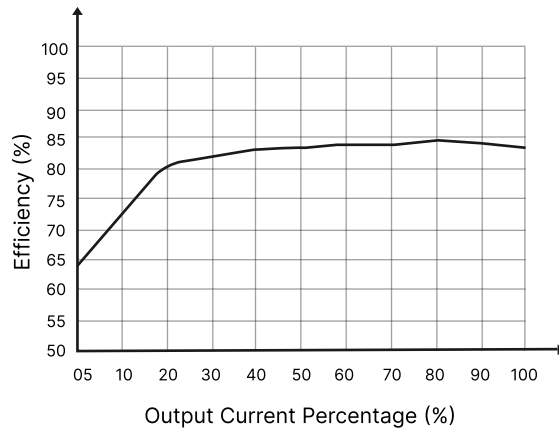

Figure 5: Efficiency Vs Output Load

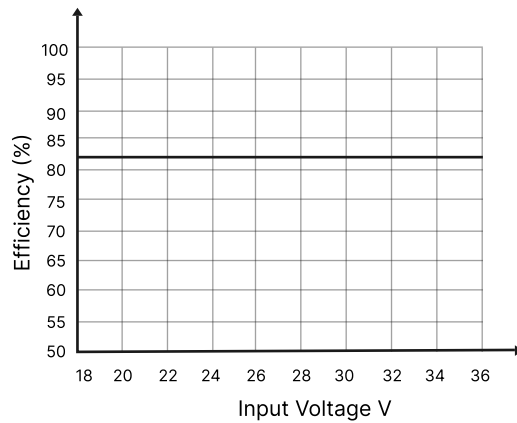

Figure 6: Efficiency Vs Input Voltage

OVERALL DIMENSIONS AND PIN FUNCTIONS

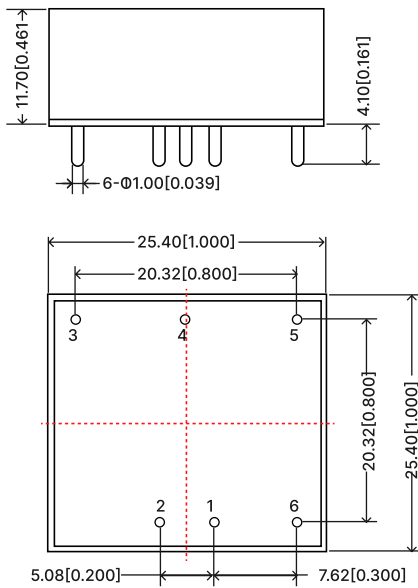

Figure 7: Overall dimensions

Table 3: Pin Function Table

Pin	Function
1	GND
2	Vin
3	+Vo
4	No Pin
5	0V
6	No Pin

*NC cannot be connected to any external circuits

PACKAGING METHOD

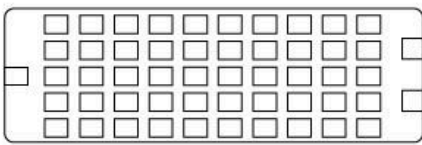

50 Pieces/Tube

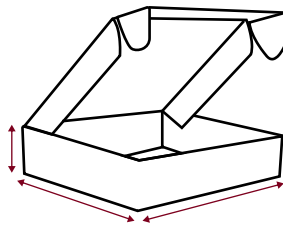

100 Pieces/Inner box

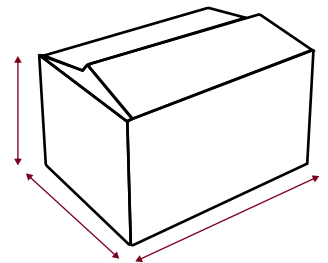

500 Pieces/Outer box

NOTES & INSTRUCTIONS

- 1.The input voltage shall not exceed the specified range value, otherwise permanent and unrecoverable damage maybe caused;
2. Unless otherwise specified,the parameters in this manual are measured at 25 °C,40%~75% humidity, input nominal voltage and output pure resistance mode under full load;
- 3.All index test methods are based on the company's enterprise standards.
- 4.The copyright and the final interpretation right of the product belong to HENXV.