

### DCFF\_S-3W Series



CE Report **RoHS**



### Features

- Wide operating temperature range : -40°C To +105°C
- Up to 85% efficiency
- No load current as low as 5mA
- Ripple as low as 30mVp-p
- Sustainable short-circuit protection

### Description

Fixed voltage input, Output 3W, Isolated, Unregulated, Single output, SIP package, 3KV isolation voltage.

### Model Numbering

## DCFFxxxxS-3W



### Selection Guide

Product Model	Input Voltage Standard Value(range)	Output Voltage	Output Current (mA) (Max./Min.)	Efficiency % (Min./Typ.)	Maximum capacitive load ( $\mu$ F)
DCFF0303S-3W	3.3VDC (2.97-3.63)	3.3	600/60	74/79	2400
DCFF0305S-3W		5	600/60	79/85	2400
DCFF0309S-3W		9	333/33	79/85	1000
DCFF0312S-3W		12	250/25	79/85	560
DCFF0315S-3W		15	200/20	81/86	560
DCFF0324S-3W		24	125/13	81/86	220
DCFF0503S-3W	5VDC (4.5-5.5)	3.3	600/60	74/79	2400
DCFF0505S-3W		5	600/60	79/85	2400
DCFF0509S-3W		9	333/33	79/85	1000
DCFF0512S-3W		12	250/25	79/85	560
DCFF0515S-3W		15	200/20	81/86	560
DCFF0524S-3W		24	125/13	81/86	220

Product Model	Input Voltage Standard Value(range)	Output Voltage	Output Current (mA) (Max./Min.)	Efficiency % (Min./Typ.)	Maximum capacitive load ( $\mu$ F)
DCFF0903S-3W	9VDC (8.1-9.9)	3.3	600/60	74/79	2400
DCFF0905S-3W		5	600/60	79/85	2400
DCFF0909S-3W		9	333/33	79/85	1000
DCFF0912S-3W		12	250/25	79/85	560
DCFF0915S-3W		15	200/20	81/86	560
DCFF0924S-3W		24	125/13	81/86	220
DCFF1203S-3W	12VDC (10.8-13.2)	3.3	600/60	74/79	2400
DCFF1205S-3W		5	600/60	79/85	2400
DCFF1209S-3W		9	333/33	79/85	1000
DCFF1212S-3W		12	250/25	79/85	560
DCFF1215S-3W		15	200/20	81/86	560
DCFF1224S-3W		24	125/13	81/86	220
DCFF1503S-3W	15VDC (13.5-16.5)	3.3	600/60	74/79	2400
DCFF1505S-3W		5	600/60	79/85	2400
DCFF1509S-3W		9	333/33	79/85	1000
DCFF1512S-3W		12	250/25	79/85	560
DCFF1515S-3W		15	200/20	81/86	560
DCFF1524S-3W		24	125/13	81/86	220
DCFF2403S-3W	24VDC (21.6-26.4)	3.3	600/60	74/79	2400
DCFF2405S-3W		5	600/60	79/85	2400
DCFF2409S-3W		9	333/33	79/85	1000
DCFF2412S-3W		12	250/25	79/85	560
DCFF2415S-2W		15	200/20	81/86	560
DCFF2424S-3W		24	125/13	81/86	220

**Input Characteristics**

Parameter	Conditions	Min.	Typ.	Max.	Units	
Input current (Rated Load)	Nominal voltage input@3.3VDC	3.3VDC Output		770	790	mA
		5VDC Output	--	750	770	mA
		9VDC/12VDC Output	--	740	760	mA
		15VDC/24VDC Output	--	730	750	mA
	Nominal voltage input@5VDC	3.3VDC Output	--	535	565	mA
		5VDC Output	--	475	500	mA
		9VDC/12VDC Output	--	470	495	mA
		15VDC/24VDC Output	--	465	490	mA
	Nominal voltage input@12VDC	3.3VDC Output	--	220	240	mA
		5VDC Output	--	220	215	mA
		9VDC/12VDC Output	--	200	210	mA
		15VDC/24VDC Output	--	165	175	mA
	Nominal voltage input@15VDC	3.3VDC Output	--	165	175	mA
		5VDC Output	--	155	165	mA
		9VDC/12VDC Output	--	125	160	mA
		15VDC/24VDC Output	--	125	135	mA
	Nominal voltage input@24VDC	3.3VDC Output	--	110	120	mA
		5VDC Output	--	105	115	mA
		9VDC/12VDC Output	--	100	110	mA
		15VDC/24VDC Output	--	95	105	mA
Input current (No load)		--	5	20	mA	
Reflected ripple current		3	15	20	mA	
Input impulse voltage	1sec. max.	3.3VDC/5VDC Input	-0.7	--	9	VDC
		9VDC Input	-0.7	--	12	VDC
		12VDC Input	-0.7	--	18	VDC
		15VDC Input	-0.7	--	21	VDC
		24VDC Input	-0.7	--	30	VDC
Input filter	Capacitive filtering					

Remarks: This product does not support hot plug

**Output Characteristic**

Parameter	Conditions		Min.	Typ.	Max.	Units
Output voltage accuracy			SeeFigure3 (envelope curve)			
Linear regulation rate	Input voltage variation+/-1%	3.3VDC Output	--	--	+/-1.5	%
		Other outputs	--	--	+/-1.2	%
Load regulation rate	10% to 100% load	3.3VDC Output	8	12	20	%
		5VDC Output	5	10	15	%
		9VDC Output	3	8	10	%
		12VDC Output	3	7	10	%
		15VDC Output	3	6	10	%
		24VDC Output	2	5	10	%
Ripple & Noise	20MHz bandwidth		--	30	100	mVp-p
Temperature drift coefficient	100%load		--	+/-0.03	--	%/°C
Short circuit protection	Sustainable, Self-healing					

Note: The testing method for ripple and noise is the parallel line testing method.

**General Characteristic**

Parameter	Conditions	Min.	Typ.	Max.	Units
Isolation voltage	Input-output, Test time 1 minute, Leakage current less than 1 mA	3000	--	--	VDC
Insulation resistance	Input-output, Insulation voltage 500VDC	1000	--	--	MΩ
Isolation capacitance	Input-output, 100KHz/0.1V	--	20	50	pF
Working temperature	Temperature≥ 85°C for derating (See Figure4)	-40	--	+105	°C
Storage temperature		-55	--	+125	°C
Storage humidity	Non condensing	--	--	95	%RH

Parameter	Conditions	Min.	Typ.	Max.	Units
Housing temperature rise during operation	Ta=25°C, Nominal Input, Full Output	--	15	25	°C
Soldering temperature resistance of pins	The distance from the welding spot to the shell is 1.5mm, 10 seconds	--	--	300	°C
	REFLOW: Peak temperature Tc≤245°C, maximum time above 217°C for 60 seconds.	--	--	245	°C
Switching frequency	Full load, Nominal input voltage	100	270	--	kHz
Mean time between failures 【MTBF】	MIL-HDBK-217F@25°C	3500	--	--	kHours

### Physical Characteristics

Parameter	Contents
Housing material	Black flame retardant and heat-resistant plastic (UL94V-0)
Overall dimensions	19.65 × 7.05 × 10.16mm
Weight	2.4g(Typ.)
Cooling mode	Natural air cooling

### EMC Characteristics

Parameter	Category	Content
EMI	Conductive disturbance	CISPR32/EN55032 CLASS B (The recommended circuit is shown in Figure 2)
	Radiation disturbance	CISPR32/EN55032 CLASS B (The recommended circuit is shown in Figure 2)
EMS	Electrostatic discharge	IEC/EN61000-4-2 Contact ±4KV perf. Criteria B

### Circuit Design and Application

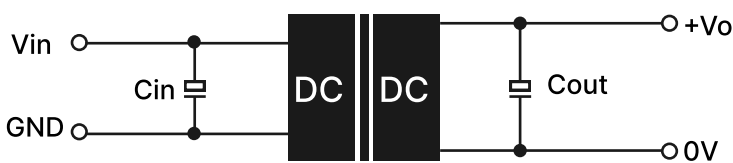

Figure 1: Application circuit

Table 1:  
Recommended Capacitive Load Values

Vin(VDC)	Cin(μF)	Vo(VDC)	Cout(μF)
Nominal voltage	1-10	Nominal voltage	2.2-22

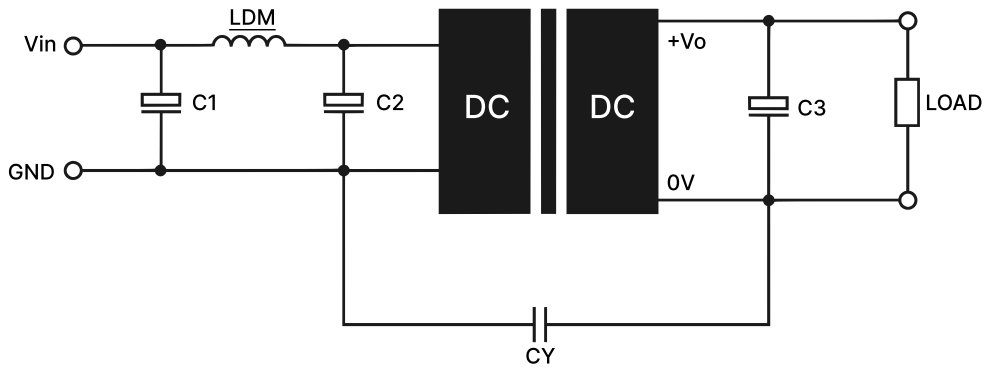

Figure 2: EMC Typical Recommended Circuits

Table 2:  
Recommended Circuit Parameter Values

Category	Component	Value
EMI	C1	4.7 $\mu$ F /50V
	C2	4.7 $\mu$ F /50V
	C3	2.2-22 $\mu$ F /50V
	CY	270pF/2kV
	LDM	6.8 $\mu$ H

1. Typical application: If further reduction of input and output ripple is required, a capacitor filter network can be connected at the input and output ends. The application circuit is shown in Figure 1. However, suitable filter capacitors should be selected. If the capacitance is too large, it may cause overcurrent or poor startup of the power supply. For each output, while ensuring safe and reliable operation, the recommended capacitance load values are shown in Table 1.

2. EMC requirements: For situations with high EMC requirements, a typical EMC recommended circuit is shown in Figure 2.

3. Input requirements: Ensure that the fluctuation range of the input voltage does not exceed the upper and lower limits of the input voltage specified in this data sheet, and the input power must be greater than the output power specified in this data sheet. For situations with a 24V input voltage, it is recommended to connect a TVS tube between the positive and negative input pins for protection (recommended parameters for TVS tubes: 30V, bidirectional, SOD-123 packaging).

4. Output load requirements: Try to avoid using it without load as much as possible; When the actual power of the load is less than 10% of the rated output power in this data sheet, or when it needs to be used in no-load situations, it is recommended to connect a load resistor externally at the output end. The load resistor can be calculated according to 5-10% of the rated power in this data sheet. The calculation formula for the load resistor value is  $R_L = V_{out}^2 / (P_{out} * 10\%)$ .

5. Overload protection: Under normal working conditions, the output circuit of this product has no protection function for overload situations. The simplest method is to connect a self recovery fuse in series at the input end, or add a circuit breaker outside the circuit; Or during design and selection, the actual power of the circuit should be around 60-80% of the rated power in this data sheet.

**Product Characteristic Curve**

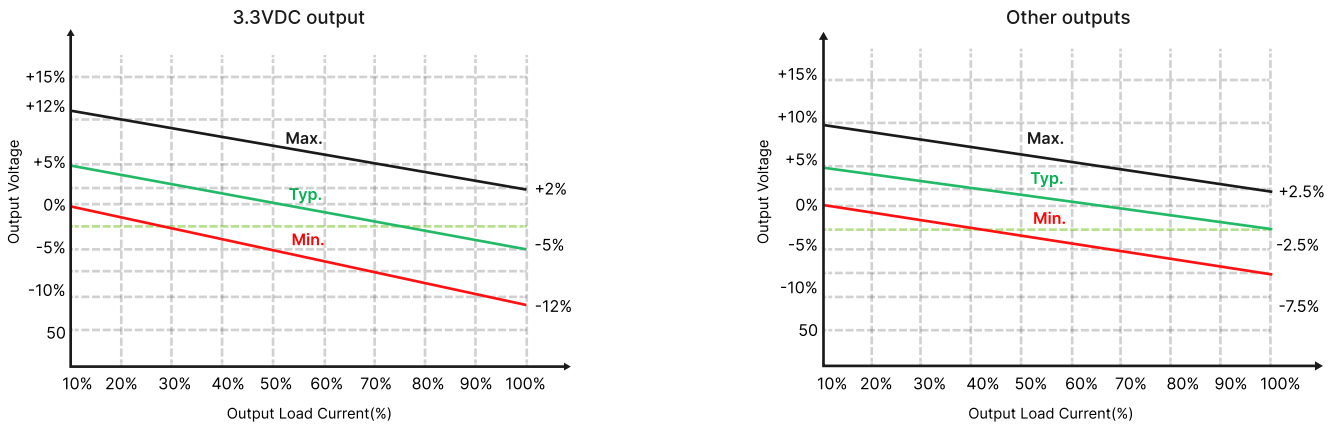

Figure 3: Voltage tolerance envelope

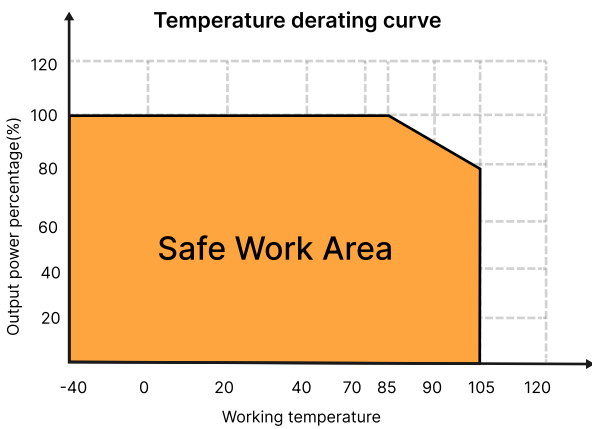

Figure 4: Temperature Derating Curve

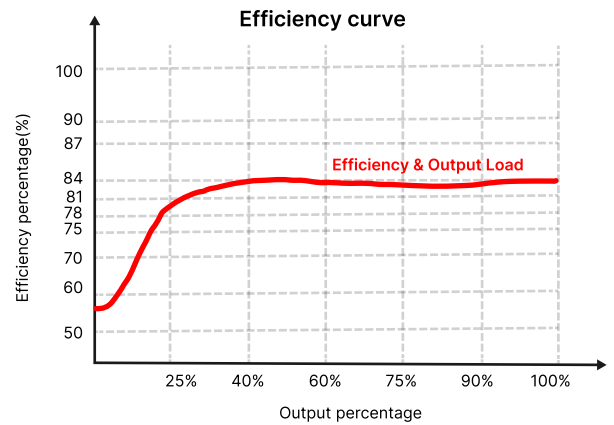

Figure 5: Efficiency Vs Output Load (Nominal Voltage Input)

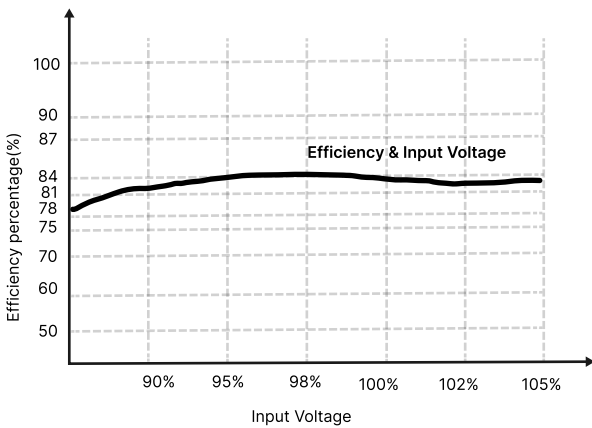

Figure 6: Efficiency Vs Input Voltage (100% Load)

Overall Dimensions and Pin Functions

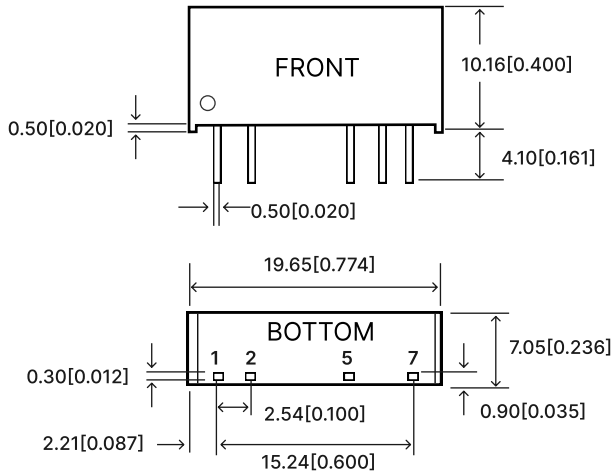

Table 3: Pin Function Table

Pin	Function
1	Vin
2	GND
5	0V
7	+Vo

Note:  
Dimensions in mm  
Terminal diameter tolerance: +/-0.10  
Undeclared tolerance: +/-0.50

Figure 7: Overall dimensions

Packaging Method

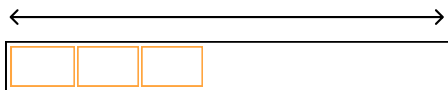

18 Pieces/Tube

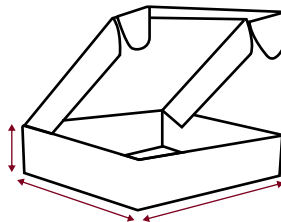

900 Pieces/Inner box

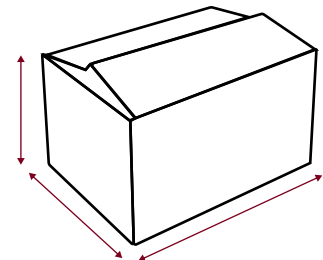

4500 Pieces/Outer box

Notes & Instructions

- 1.The input voltage shall not exceed the specified range value, otherwise permanent and unrecoverable damage maybe caused;
2. Unless otherwise specified,the parameters in this manual are measured at 25 °C,40%~75% humidity, input nominal voltage and output pure resistance mode under full load;
- 3.All index test methods are based on the company's enterprise standards.
- 4.The copyright and the final interpretation right of the product belong to HENXY.