

ACS05W-xxV Series

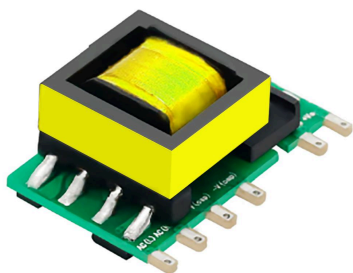

FEATURES

- Input voltage range: 85~305VAC (100~430VDC)
- Working temperature range: -40 °C to +85 °C
- Complete protection functions
- Industrial grade product technical design



DESCRIPTION

The ACS05W-xxV series is an efficient modular power supply for miniaturized bare boards, with advantages such as dual use of AC and DC, wide input voltage range, high reliability, low power consumption, and safe isolation. Widely applicable to industrial control, power instruments, smart homes, and other occasions that require strict volume requirements and low EMC requirements. If it is necessary to apply in harsh electromagnetic compatibility environments, EMC peripheral circuits must be added.

MODEL NUMBERING

ACS05W-xxV



SELECTION GUIDE

Product Model	Output Voltage (Vo)	Output Current (Io)(mA)	Output Power (W)	Efficiency (230VAC, %/Typ.)	Maximum capacitive load (uF)
ACS05W-03V	3.3	1000	3.3	69	2200
ACS05W-05V	5	1000	5	76	1500
ACS05W-09V	9	560	5	77	680
ACS05W-12V	12	420	5	75	470
ACS05W-15V	15	340	5	79	330
ACS05W-24V	24	210	5	80	100

INPUT CHARACTERISTICS

Parameter	Conditions	Min.	Typ.	Max.	Units
Input Voltage	AC Input	85	--	305	VAC
	DC Input	100	--	430	VDC
Input voltage frequency	AC Input	47	--	63	Hz
Input Current	115VAC	--	--	0.2	A
	230VAC	--	--	0.1	A
Inrush Current	115VAC	--	20	--	A
	230VAC	--	40	--	A

Remarks: This product does not support hot plug

OUTPUT CHARACTERISTICS

Parameter	Conditions	Min.	Typ.	Max.	Units
Output voltage accuracy	10% -100% load	--	+/-5	--	%
Linear regulation	Rated load	--	+/-1.5	--	%
Load regulation	10% to 100% load	--	+/-3	--	%
Minimum load		10	--	--	%
Standby power	At room temperature, 230VAC input	--	0.1	0.12	W
Ripple & Noise	20MHz bandwidth (peak to peak)	--	70	150	mV
Temperature coefficient	230VAC, 0 - 50°C, 100% load	--	+/-0.1	--	%/°C
Short circuit protection	Hiccup type, capable of long-term short circuit and self recovery				
Overcurrent protection	>110% I _o , Self recovering				
Over Temperature Protection	Hiccup mode, self recovery				

Note: The testing method for ripple and noise is parallel line testing, and a 100uF electrolytic capacitor and a 0.1uF ceramic capacitor need to be connected in parallel at the output end.

GENERAL CHARACTERISTIC

Parameter	Conditions		Min.	Typ.	Max.	Units
Isolation voltage	Input-Output	Test time 1 minute, Leakage current less than 5mA	3600	--	--	VAC
			5000	--	--	VDC
Insulation resistance	Input-Output	Environmental temperature: 25 ± 5 °C, Relative humidity: less than 95% RH, uncondensed, Test voltage: 500VDC.	100	--	--	MΩ
Working temperature			-40	--	+85	°C
Storage temperature			-40	--	+90	°C
Working humidity			20	--	85	%RH
Storage humidity			10	--	95	%RH
Switching frequency			--	65	--	KHz
Output power derating	Operating temperature derating	-20°C to -10°C	2.75	--	--	%/°C
		+50°C to +70°C	1.67	--	--	%%°C
	Input voltage derating	85VAC-100VAC	1.33	--	--	%/VAC
		277VAC-305VAC	0.71	--	--	%/VAC
	Altitude derating	2000m-5000m	0.67	--	--	%/Km
Leakage current	230VAC/50Hz	<0.1mA,RMS Max				
Mean Time Between Failures 【MTBF】	MIL-HDBK-217F@25°C	1000	--	--	kHours	

PHYSICAL CHARACTERISTICS

Parameter	Contents
Housing material	None (bare board)
Overall dimensions	26.4*19.6*11.5mm (L*W*H)
Weight	5.2g (Typ.)
Cooling mode	Natural air cooling

CIRCUIT DESIGN REFERENCE

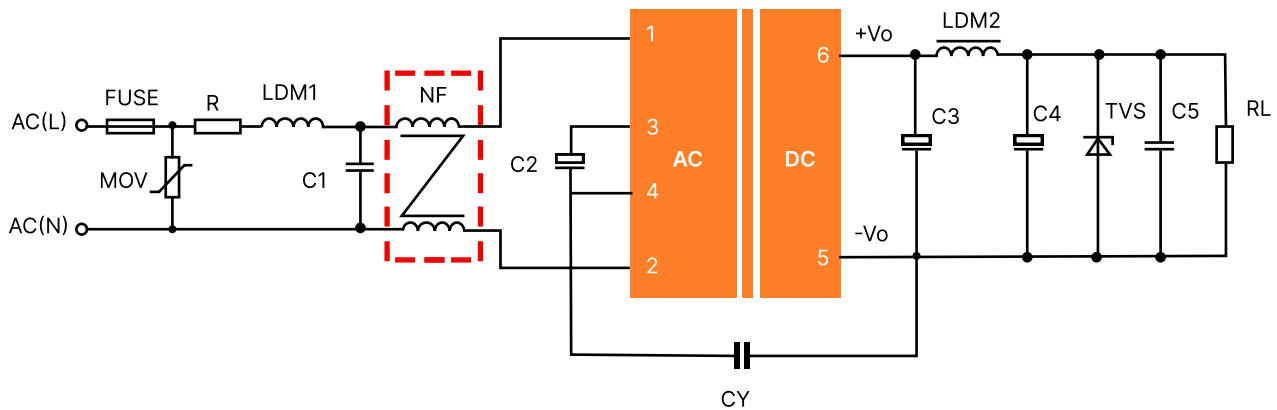

Component	Value
FUSE	1A/300V, Slow break
MOV	10D561K
R	Insurance resistor100/1
LDM1	4.7mH/Max: 150/Min: 0.2A
NF	The common mode inductance NF inside the dashed box is not required, and the common mode inductance L=30mH. When higher EMC requirements need to be met, this inductance needs to be added.

Component	Value
C1	104K/275Vac
C2	10 μ F/450V
C3,C4	220 μ F-1000 μ F
C5	104K/50V
TVS	Select by voltage
LDM2	4.7uH/60mQ/2.2A

PRODUCT CHARACTERISTIC CURVE

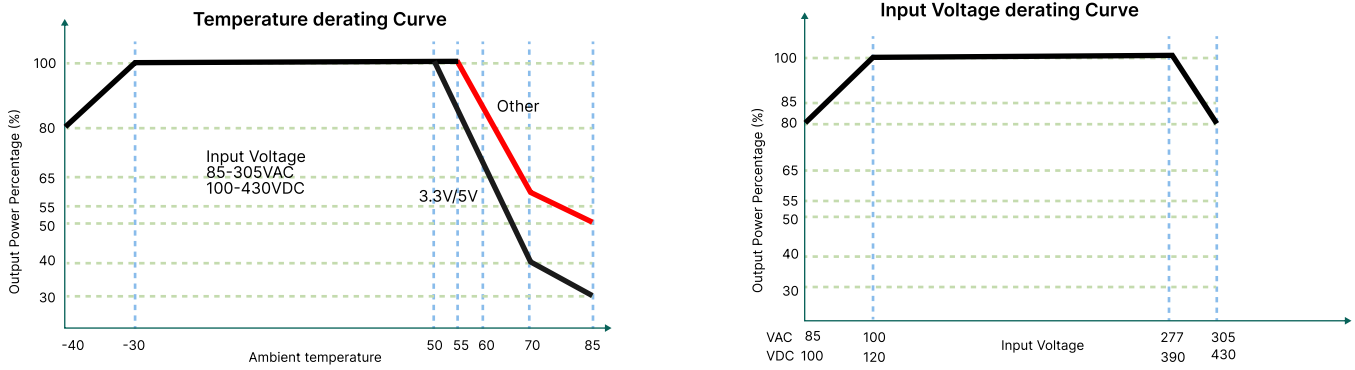

Figure 3: Voltage tolerance envelope

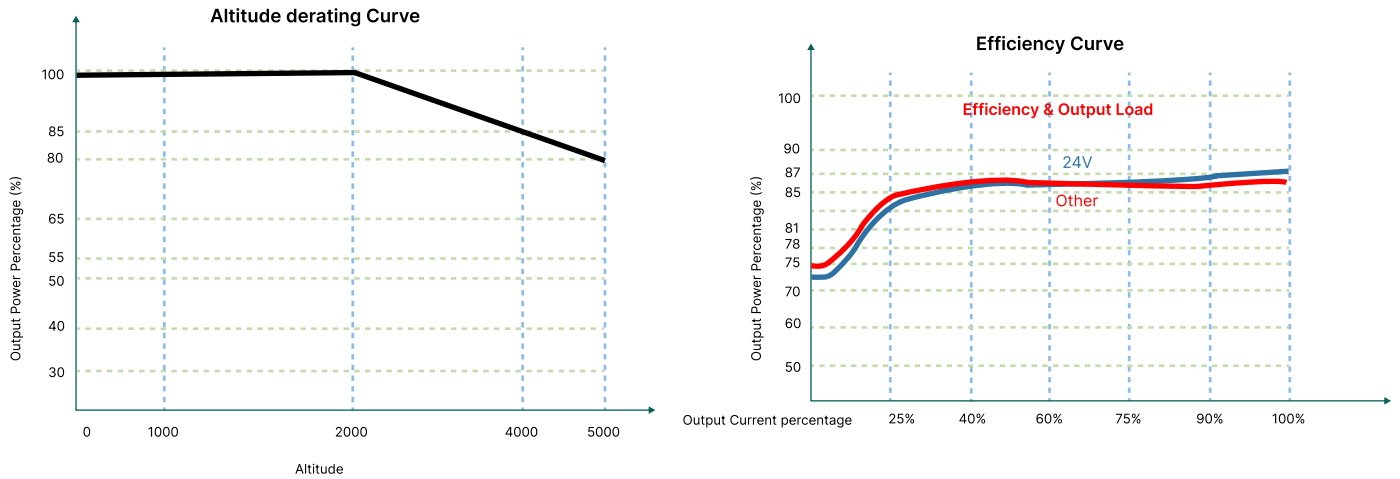

Figure 4: Temperature Derating Curve

Figure 5: Efficiency VS Output Load (Nominal Voltage Input)

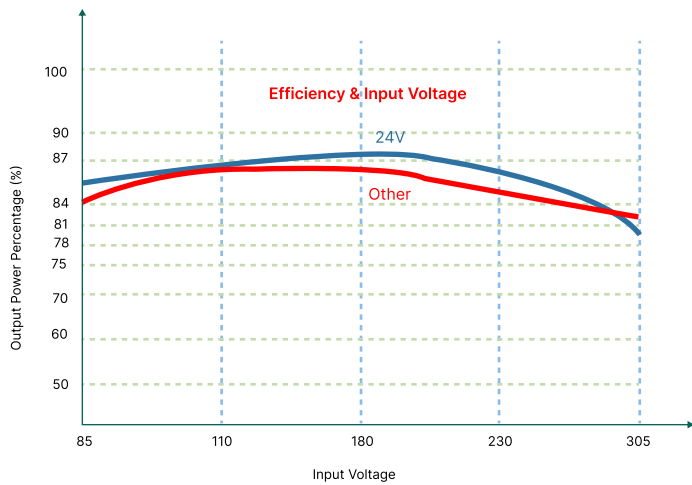

Figure 6: Efficiency VS Input Voltage (100% Load)

OVERALL DIMENSIONS AND PIN FUNCTIONS

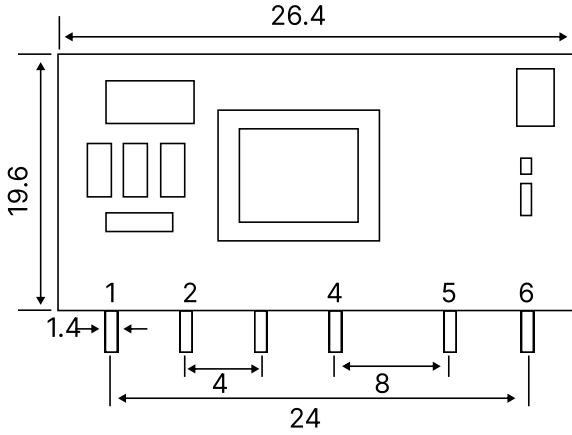

Figure 7: Overall dimensions

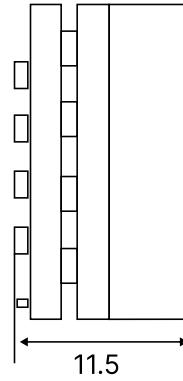
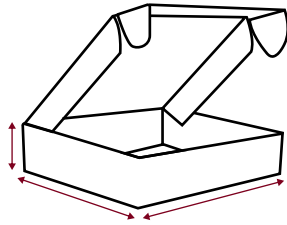

Table 3: Pin Function Table

Pin	Function
1	AC(L)
2	AC(N)
3	+V(cap)
4	-V(cap)
5	-Vo
6	+Vo

Note:
Dimensions in mm [inch]
Terminal diameter tolerance: ± 0.10 [± 0.004]
Undeclared tolerance: ± 0.50 [± 0.020]

PACKAGING METHOD



150 Pieces/Inner box

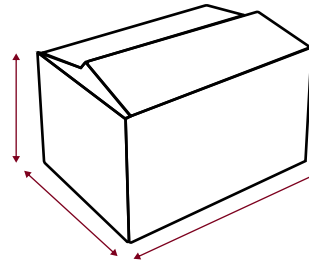

750 Pieces/Outer box

NOTES & INSTRUCTIONS

1. The input voltage shall not exceed the specified range value, otherwise permanent and unrecoverable damage maybe caused;
2. Unless otherwise specified, the parameters in this manual are measured at 25 °C, 40%~75% humidity, input nominal voltage and output pure resistance mode under full load;
3. All index test methods are based on the company's enterprise standards.
4. The copyright and the final interpretation right of the product belong to HENXY.